

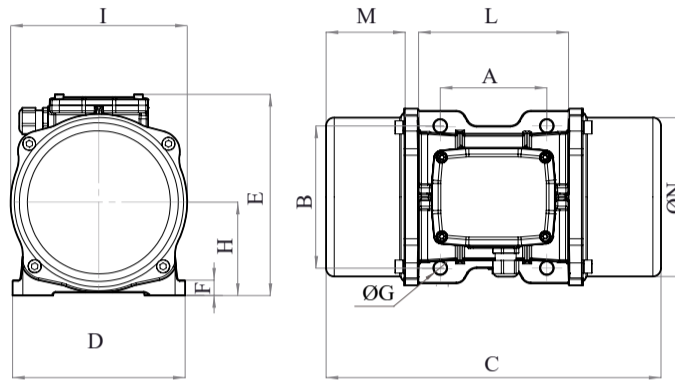

MVE 1540/4E-50A0 (EE40071050A0LA000U)

3 PH - 4 poles - 1800 RPM - 230/460 V - 60 Hz

Working moment (Lb*in)	Unbalance (Lb*in)	Centrifugal force (Lb)	Nominal voltage (V)	Input power (Hp)	Current (A)	Power factor	Ia/In
34.17	17.09	1,569.69	230/460	0.98	Δ 2.4 Y 1.2	0.76	3.4



*Technical drawings are illustrative purposes only, please refer to 2D/3D drawings available on "FINDER" app. Contact us for more information.

OVERALL DIMENSIONS [inches]													
Weight (Lb)	A	B	G	Holes number	C	D	E	F	H	I	L	M	N
59.52	4.72	6.69	0.67	4	15.39	8.19	8.27	0.87	3.78	7.28	7.56	3.82	6.69

TECHNICAL FEATURES						
Type of grease	Greased for life	Screw	Washer	Clamping torque (Ft-Lb)	Cable type	Cable gland
Please refer to the label on the motorvibrator	Yes	5/8"	0.656"x1.312"	136.35	16-4c 120°C	/

BEARINGS LIFE HOURS				
Bearing model	Type	100% C.F	80% C.F	50% C.F
NJ 306		46440	97706	>100000

CERTIFICATION	
ATEX II2 D Ex tb IIIC Tx Db IP66 IECEx Ex tb IIIC Tx Db IP66 CLASS II DIV.2 GROUP F,G T4 Ex tb IIIC Tx Db IP66 [Tx Size Micro,10-30:100°C - Tx Size 40-91:135°C] CONFTO UL1004-3, UL1004-1, UL 60079-0, UL60079-31 CERT. CSA C22.2 No.100, CSA C22.2 No.77, CSA C22.2N.60079-0, CSA C22.2N. 60079-31 T.Amb -20/+40°C	

REV.1-22/05/2019

Dimension with coarse degree of accuracy related to UNI 22768/1 Rights reserved to modify technical specifications.

